

# LC50-12M

## High-efficiency PV Module

### Features

- high energy yields ensured by high conversion efficiency
- sturdy, clear-anodized aluminum frame with pre-drilled holes for quick installation
- advanced EVA encapsulation with triple-layer backsheets, meets the most stringent safety requirements for high-voltage operation
- reliable bypass diodes to prevent overheating (hot spot effect) and to minimise power loss by shading
- manufactured in ISO 9001:2000-certified factory

### Applications

- water pumping
- water purification systems
- remote village lighting
- solar home systems
- street and camp lights
- traffic signals
- medical facilities in remote areas
- microwave/radio repeater stations
- battery charging
- etc.

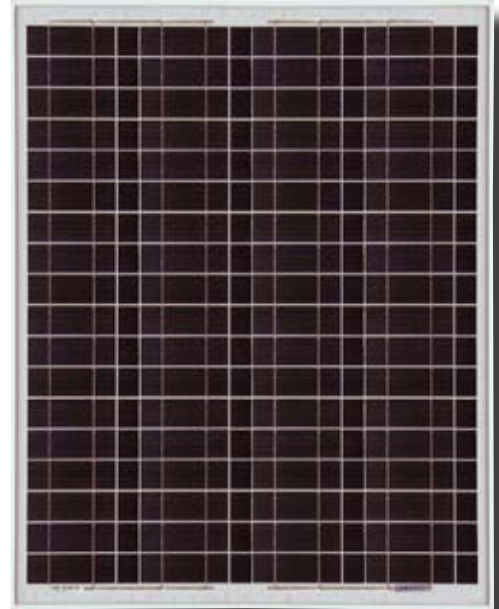

photo may differ from actual product

### Warranty

- Warranty: 2 years
- Performance guarantee:  
up to 10 years (90% power output)  
up to 20 years (80% power output)

Details according to warranty issued by LORENTZ

### Standards

LC50-12M meets the requirements for CE and IEC.



### Specifications

#### Electrical Data

Peak power	P <sub>max</sub>	[Wp]	50
Tolerance		[%]	+ 15/-5
Max. power current	I <sub>mp</sub>	[A]	2.9
Max. power voltage	V <sub>mp</sub>	[V]	17.2
Short circuit current	I <sub>sc</sub>	[A]	3.2
Open circuit voltage	V <sub>oc</sub>	[V]	21.6
Temperature co-efficient for P <sub>max</sub>		[%/°C]	-0.50
Temperature co-efficient for V <sub>oc</sub>		[%/°C]	-0.35
Temperature co-efficient for I <sub>sc</sub>		[%/°C]	0.09
Max. system voltage		[V]	600

All technical data at standard test condition:  
AM = 1.5, E = 1,000W/m<sup>2</sup>, cell temperature: 25 °C

#### Cells

Number of cells in series	36
Number of cells in parallel	2
Cell technology	monocrystalline
Cell shape	rectangular

**Electrical Performance**

**Electrical Performance**

for different temperatures, at AM=1.5, E=1,000W/m<sup>2</sup>

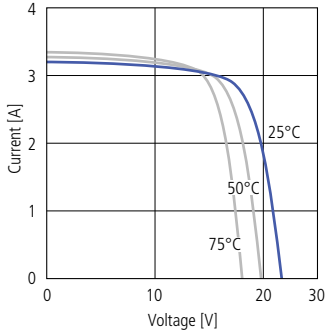

**Electrical Performance**

for different irradiation, at 25 °C

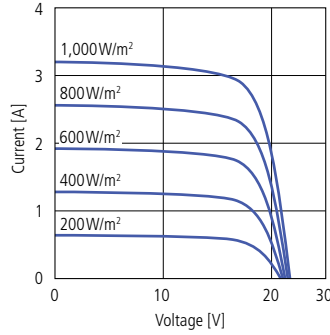

**Temperature Dependence**

of I<sub>sc</sub>, V<sub>oc</sub> and P<sub>max</sub>

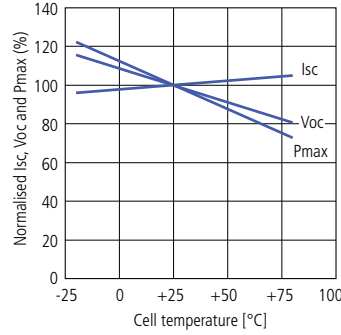

**Irradiation Dependence**

of I<sub>sc</sub>, V<sub>oc</sub> and P<sub>max</sub> at 25 °C

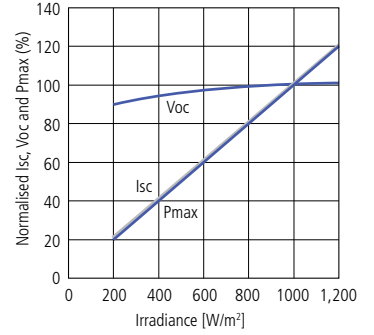

**Physical Specifications mm [in]**

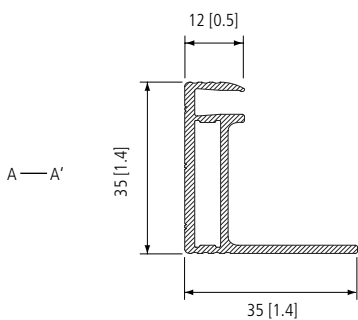
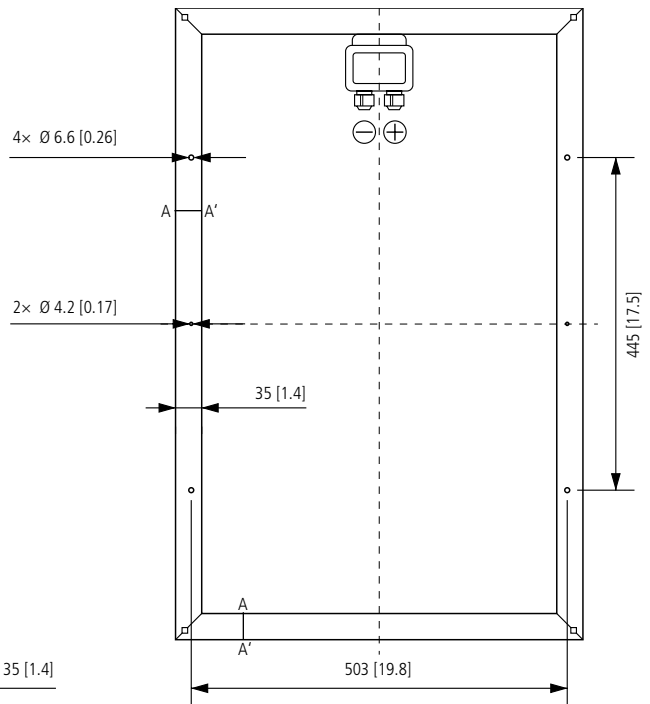
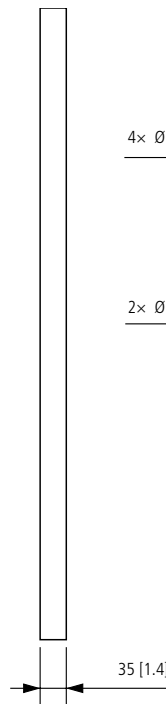
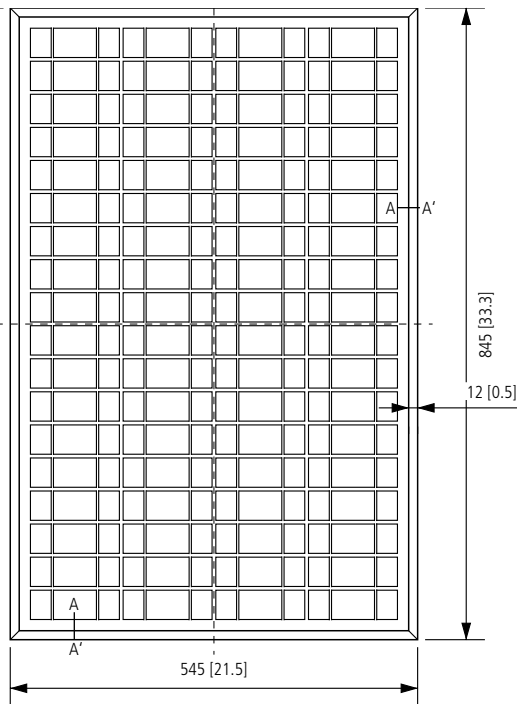

Weight	[kg]	7.0
Dimension	[mm]	545 × 845 × 35